

peplink

#PeplinkTeknolojiGünü

Aytan KIZILTAN  
Vitel

Senior Consultant (Network Solutions)

vitel.com.tr

vitel



# Yat, Gemi ve Limanlar :

SIM Injector, IP67, Anten Tasarımı



#PeplinkTeknolojiGünü



# Ortam ve Bağlantı Tipleri

- Farklı bağlantı tipleri arasında otomatik geçiş.
- Bağlantı tiplerine farklı öncelikler tanımlayarak, düşük öncelikli linkleri ihtiyaç olduğunda devreye alma

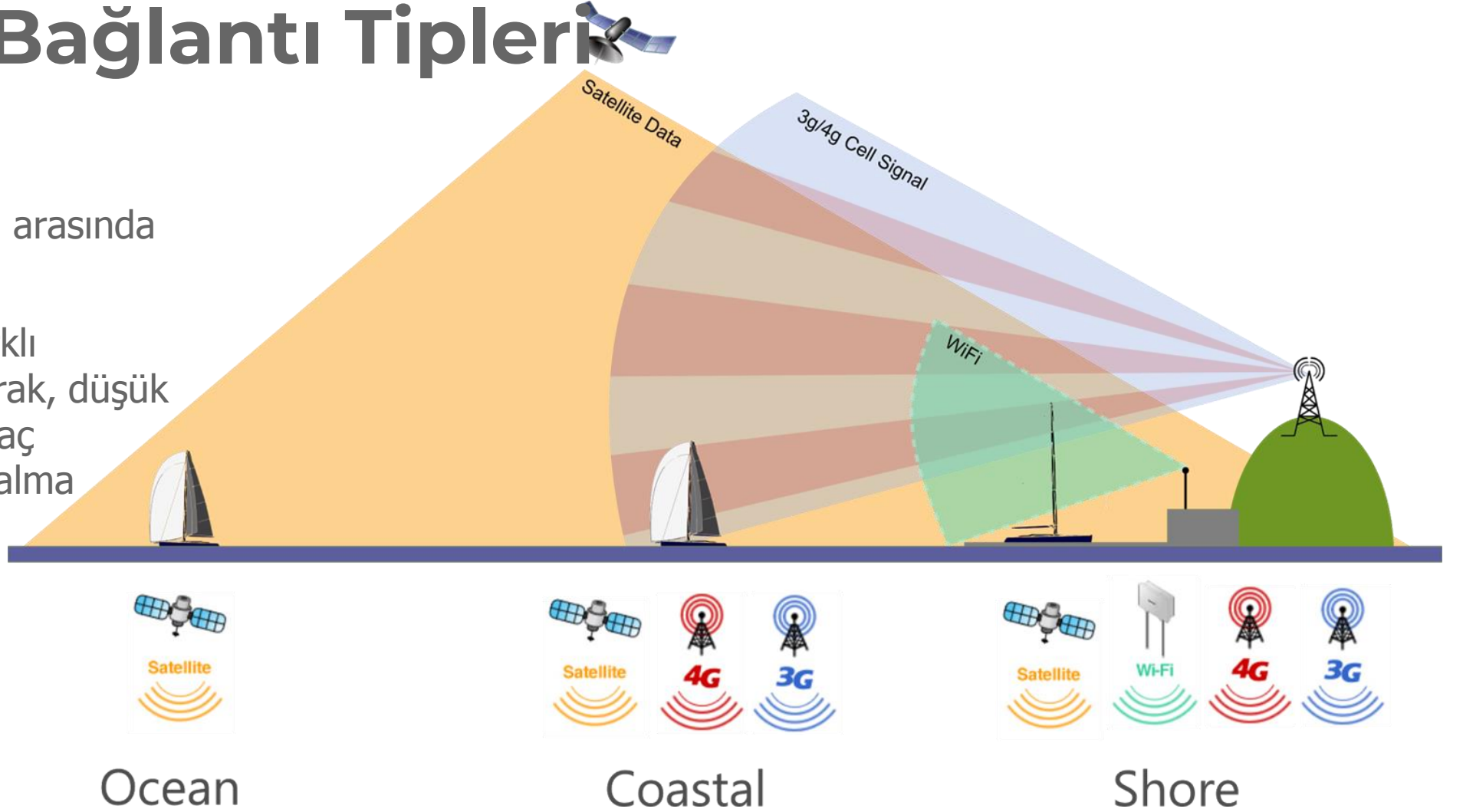

#PeplinkTeknolojiGünü

peplink

vitel

# Ekipman ve Kurulum

Klasik yaklaşıma göre 4 ana Kriter

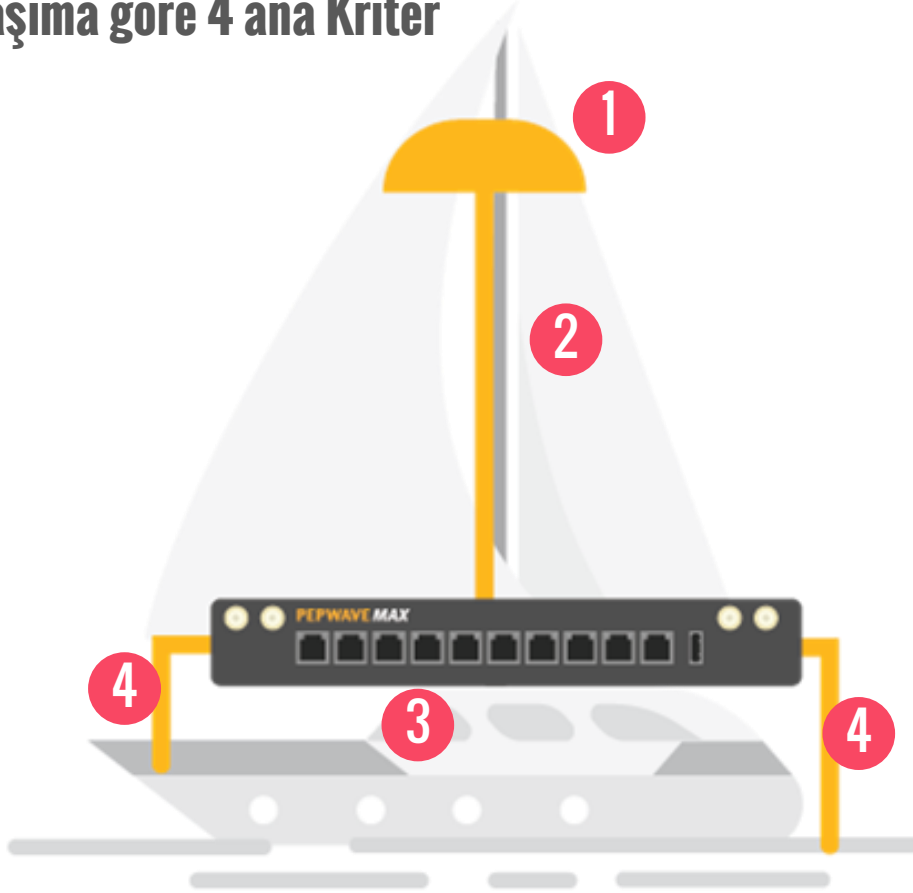

1 Anten Lokasyonu

2 Anten Kablosu

3 Router Lokasyonu

4 Lightning Koruması & Topraklama

# Anten Seçimi

- **Omni vs Directional:** Omni anten 360° alana yayın yapan çoklu yönlü antenin birleşimi gibi düşünülebilir. Yönlü anten ise tek bir yöne belli bir açı ile odaklanmış antendir.
- **Gain:** Doğru kazançlı anteni seçmek önemlidir. Düşük kazanç, kısa kapsama alanı ile sonuçlanır. Yüksek kazanç ise uzun mesafe sağlar ancak kapsama alanı daralır.

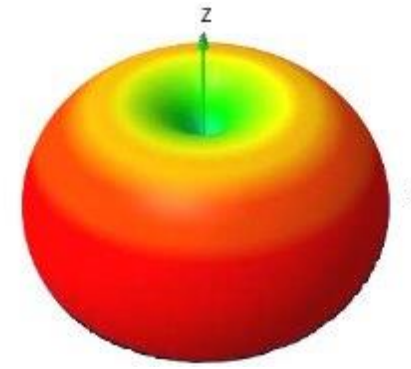

Omni-directional

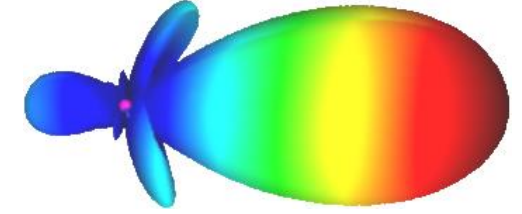

Directional

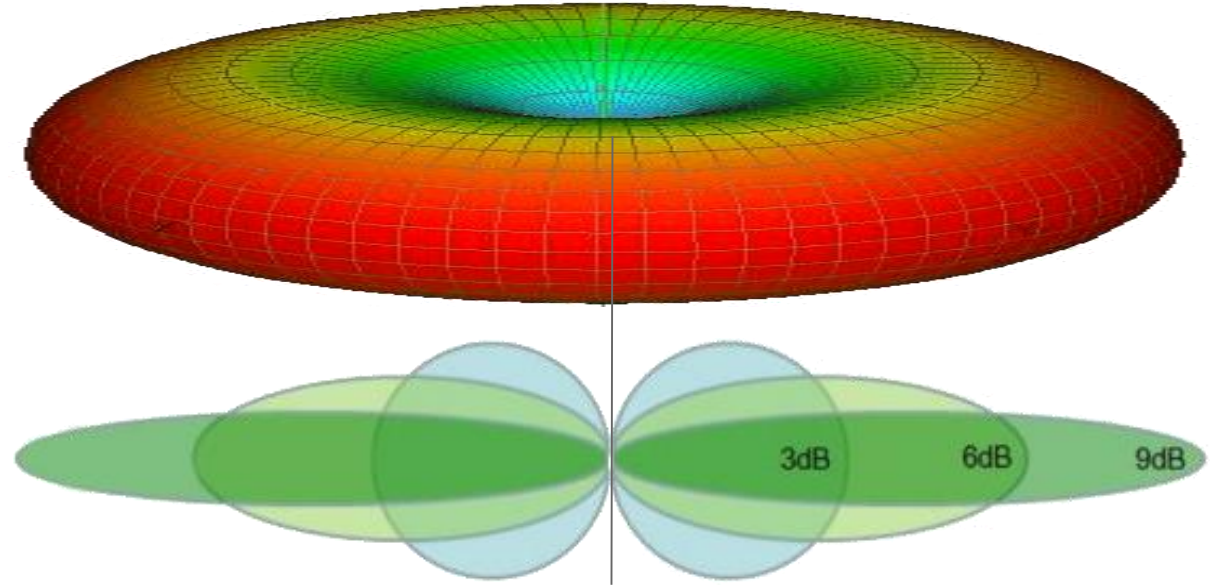

**Doğru Seçim : 6-8dBi Omni Anten**

Reference: <https://www.wilsonproway.com/blog/directional-or-omnidirectional-which-antenna-is-best/>

#PeplinkTeknolojiGünü

# Antenna Puma 401

4x4 MIMO 5G Ready Cellular Antenna System with GPS Receiver

Transport



#PeplinkTeknolojiGünü



- 6 dBi Gain, 4x4 MIMO, 5G ready, LTE & GPS
- Super Wideband 698-6000 MHz LTE Antenna
  - 4x LTE SMA connectors
  - 1x GPS SMA connector
  - Also available with QMA connectors for CAT-18 MBX
- Single Puma 401 supports
  - 2x CAT-12 cellular modems OR [> datasheet <](#)
  - 1x CAT-18 cellular modem



# Antenna ANT-107

Omnidirectional LTE/GPS Antenna

Transport



- 4X4 MIMO, High gain
- Super Wideband 698-3800 MHz LTE Antenna
  - 4x LTE SMA connectors
  - 1x GPS SMA connector
  - Available with QMA connectors for CAT-18
- Single ANT-107 supports
  - 2x CAT-12 cellular modems OR
  - 1x CAT-18 cellular modem

#PeplinkTeknolojiGünü



# 2 Anten Kablosu

## Koaksiyel Anten Kablosu

Bir yat için 25 metre uzunluğunda 3500MHz'de 6dBi kazanç verecek bir anten için hangi tip kablo en iyi seçim olur?

<https://www.timesmicrowave.com/Calculator>

**TIMES MICROWAVE SYSTEMS**  
An Amphenol Company

in f y Products Markets Resources News Careers About Us

### Coaxial Cable Attenuation & Power Handling Calculator

1 Cable Type: LMR-200

2 Frequency (MHz): 3500

3 Run Length (ft): 82

Send Calculation via Email

RESET CALCULATE

**Product Performance Parameters**

Nominal Attenuation	20.1 dB/100 ft, 66.1 dB/100 m
Average Power	0.1 kW
Cable Vg	83.0%
Nominal Td	1.2 ns/ft, 4.0 ns/m
Capacitance	24.5 pF/ft, 80.3 pF/m
Typical Connector Loss	0.1 dB/pair

**Cable Assembly Performance**

Maximum Cable Assembly Insertion Loss	18.3 dB
Cable Run Efficiency	2.2%
Cable Run Time Delay	100.4 ns

5

Eğer antenin yeterli kazancı ( Gain power ) yoksa, daha yüksek sınıf bir kablo seç

#PeplinkTeknolojiGünü





# Anten Kablosu

## Koaksiyel Anten Kablosu

<https://www.timesmicrowave.com/Calculator>



Products

Markets

Resources

News

Careers

About Us



## Coaxial Cable Attenuation & Power Handling Calculator

1

LMR-600

Frequency (MHz)

3500

Run Length (ft)

82

Send Calculation via Email

RESET

CALCULATE

### Product Performance Parameters

Nominal Attenuation 5.4 dB/100 ft, 17.7 dB/100 m

Average Power 0.4 kW

Cable Vg 87.0%

Nominal Td 1.2 ns/ft, 3.8 ns/m

Capacitance 23.4 pF/ft, 76.6 pF/m

Typical Connector Loss 0.1 dB/pair

### Cable Assembly Performance

Maximum Cable Assembly Insertion Loss 5.0 dB

Cable Run Efficiency 36.2%

Cable Run Time Delay 95.8 ns

Sadece LMR-600 kablo can cover the gain loss for such setting

#PeplinkTeknolojiGünü



# Splitter

- Birden fazla LTE modemün ortak bir anteni kullanmasını sađlamanın yöntemi. Ancak sinyal gücünü yarıya düşürür.

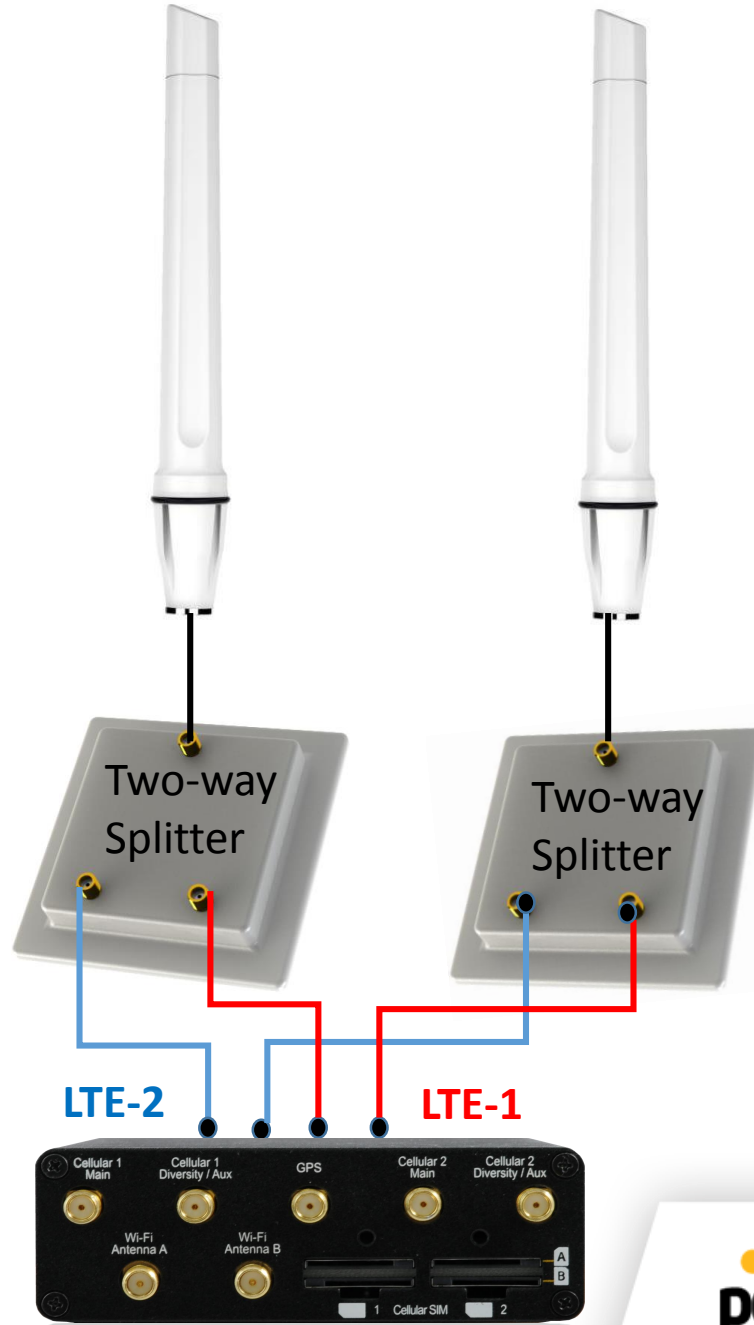

#PeplinkTeknolojiGünü



# Topraklama & Yıldırım Koruması

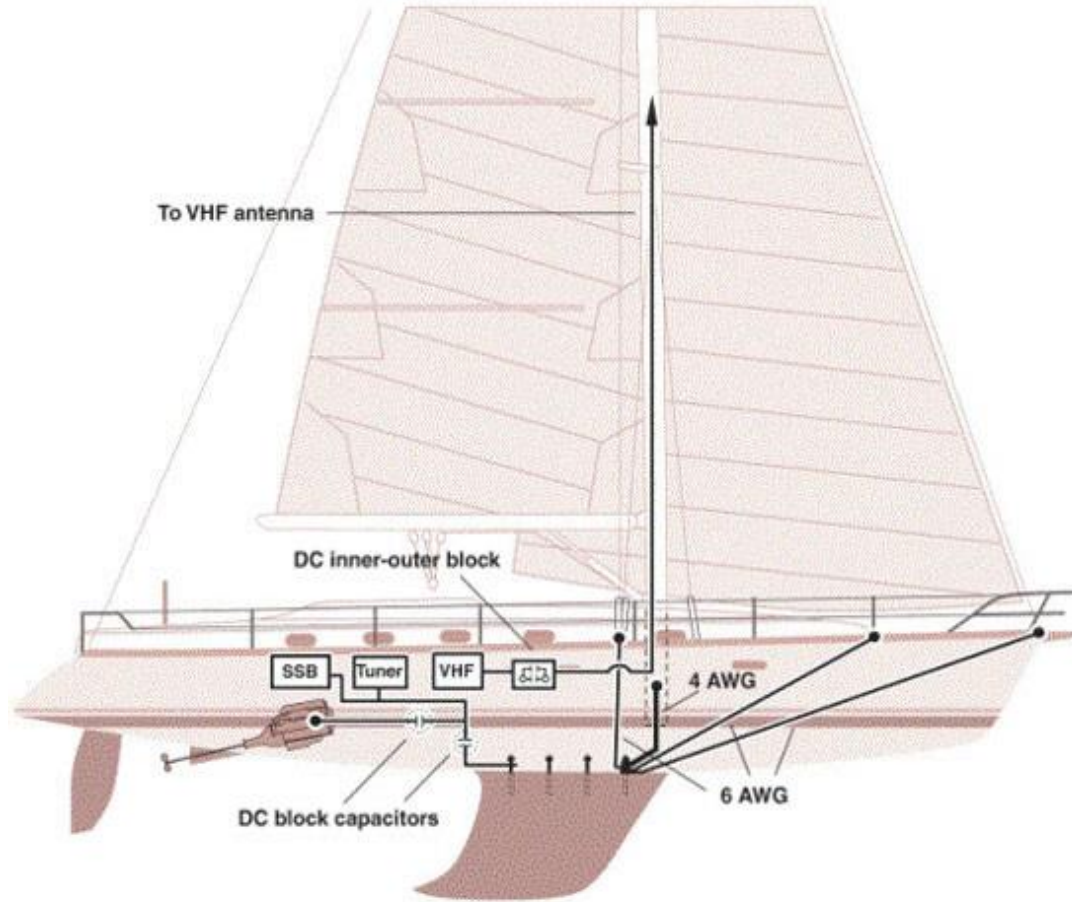

## Key notes

1. Bot ve Yatlar, Yıldırım için müthiş bir yol oluşturur. Bu nedenle yıldırım koruması vazgeçilmezdir.
2. **Metal** gövdeli bir Bot ise gövdeye topraklama yapılabilir.
3. **Fiberglass** botlarda ise , teknenin dışında mümkün olduğunda suyun altında bir piringç plaka iş görür.

# Kablo & Antenleri kontrol edelim



- Passive Splitters
- Uzun kablo Kullanma
- Düşük kaliteli/Yüksek kayıplı kablo
- Çok fazla Konnektör
- Anteni Kötü konumlama  
(kör nokta)
- Kötü anten seçimi
- Topraklam yok



- Splitter yok
- Kısa anten kablosu
- Yüksek kaliteli/ düşük kayıplı kablo
- Az konnektör
- Anteni iyi konumlama  
(360° engelsiz)
- İyi anten seçimi
- Doğru Topraklama

# Tipik Topoloji 1

Wireless router - Wired router

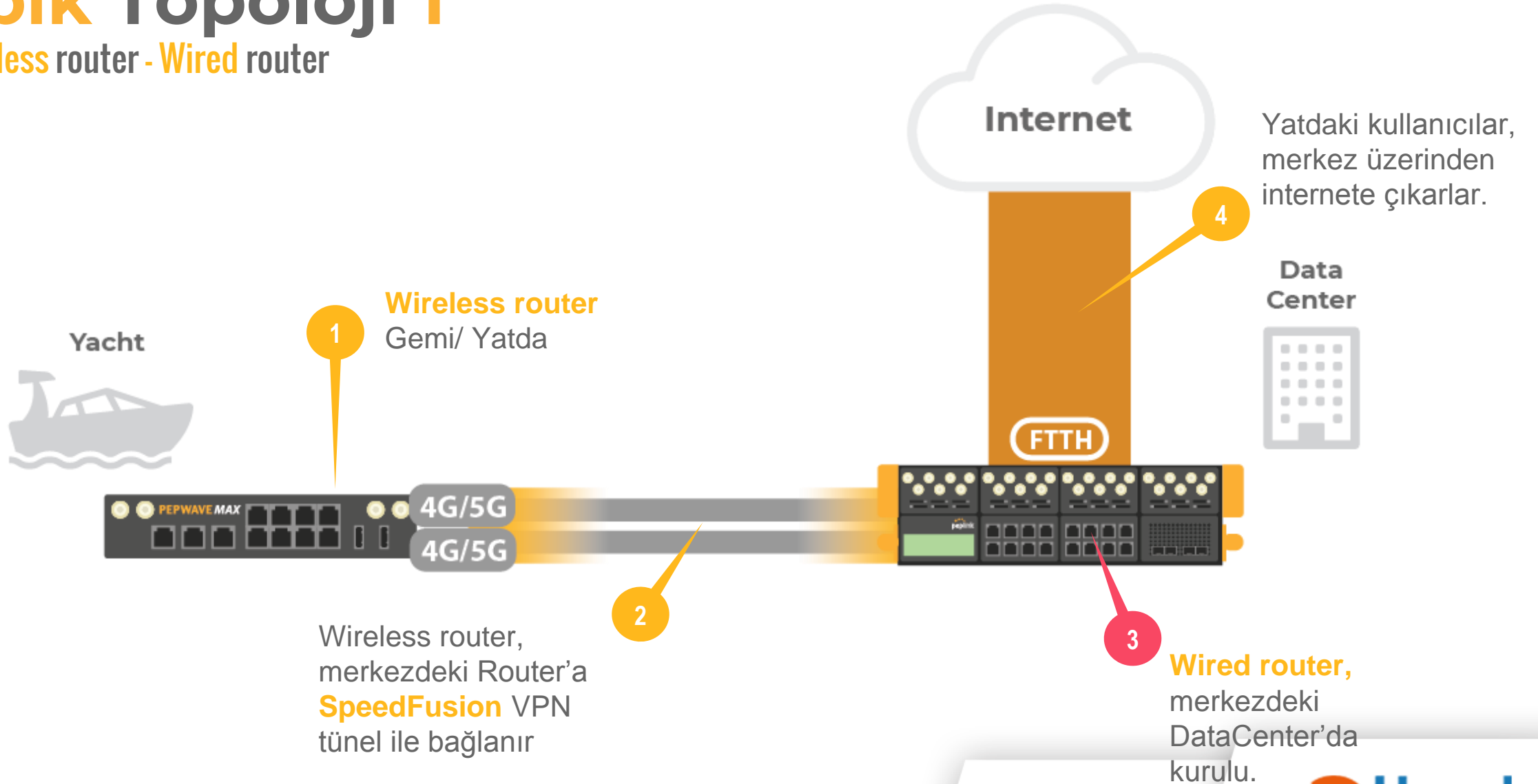

#PeplinkTeknolojiGünü



# Tipik Topoloji 2

Wireless router - Virtual appliance

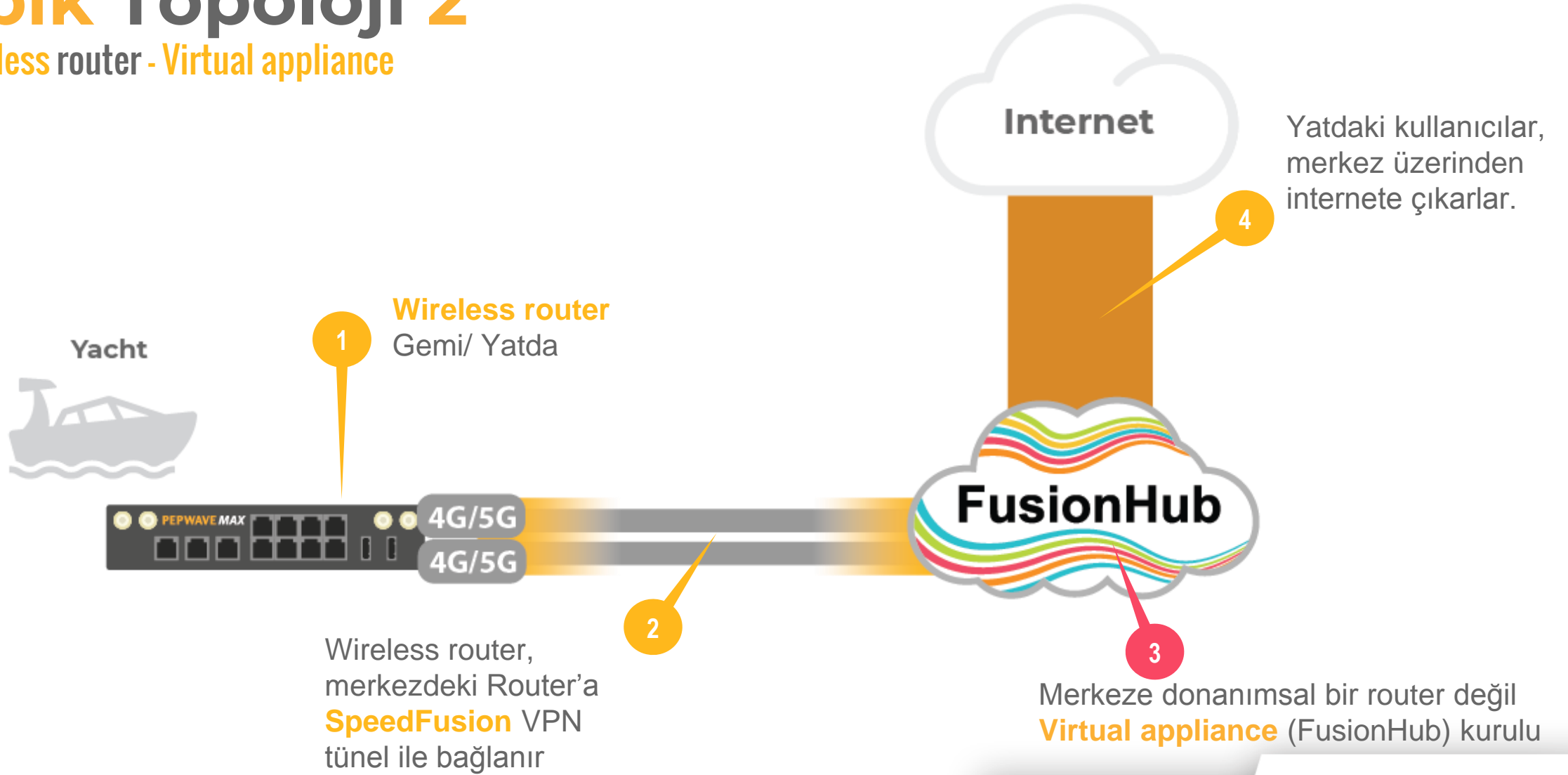

#PeplinkTeknolojiGünü



# Tipik Topoloji 3

Wireless router - SaaS (Software as a Service)

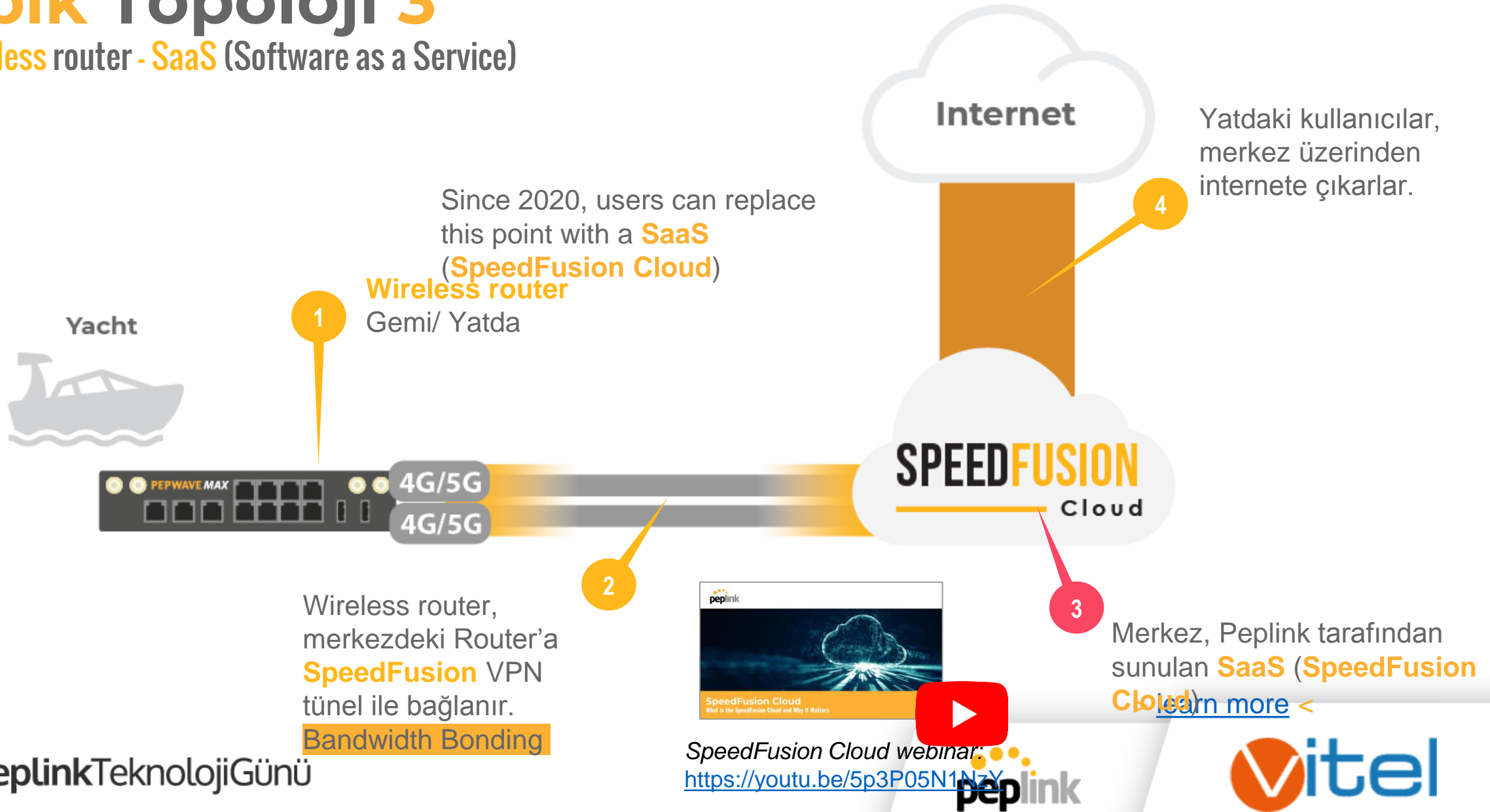

# Tipik Topoloji 4

Wireless router - Virtual appliance

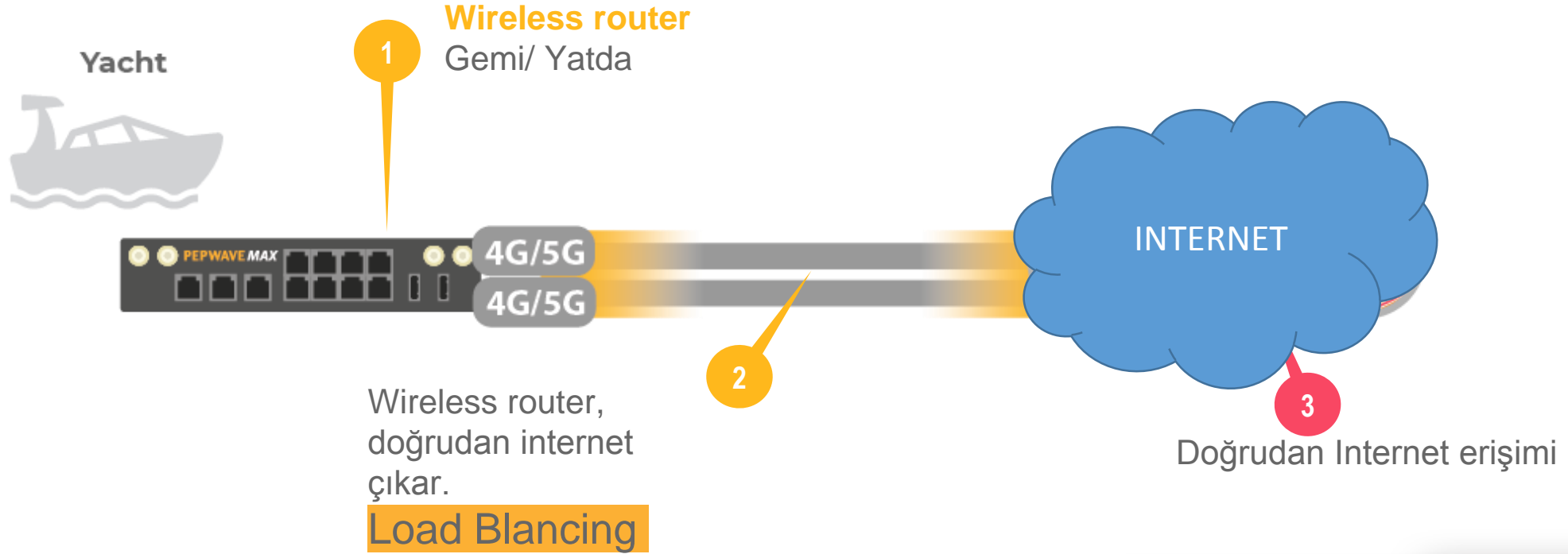

#PeplinkTeknolojiGünü





# Yat Üstünde Bağlantı Topolojisi 1

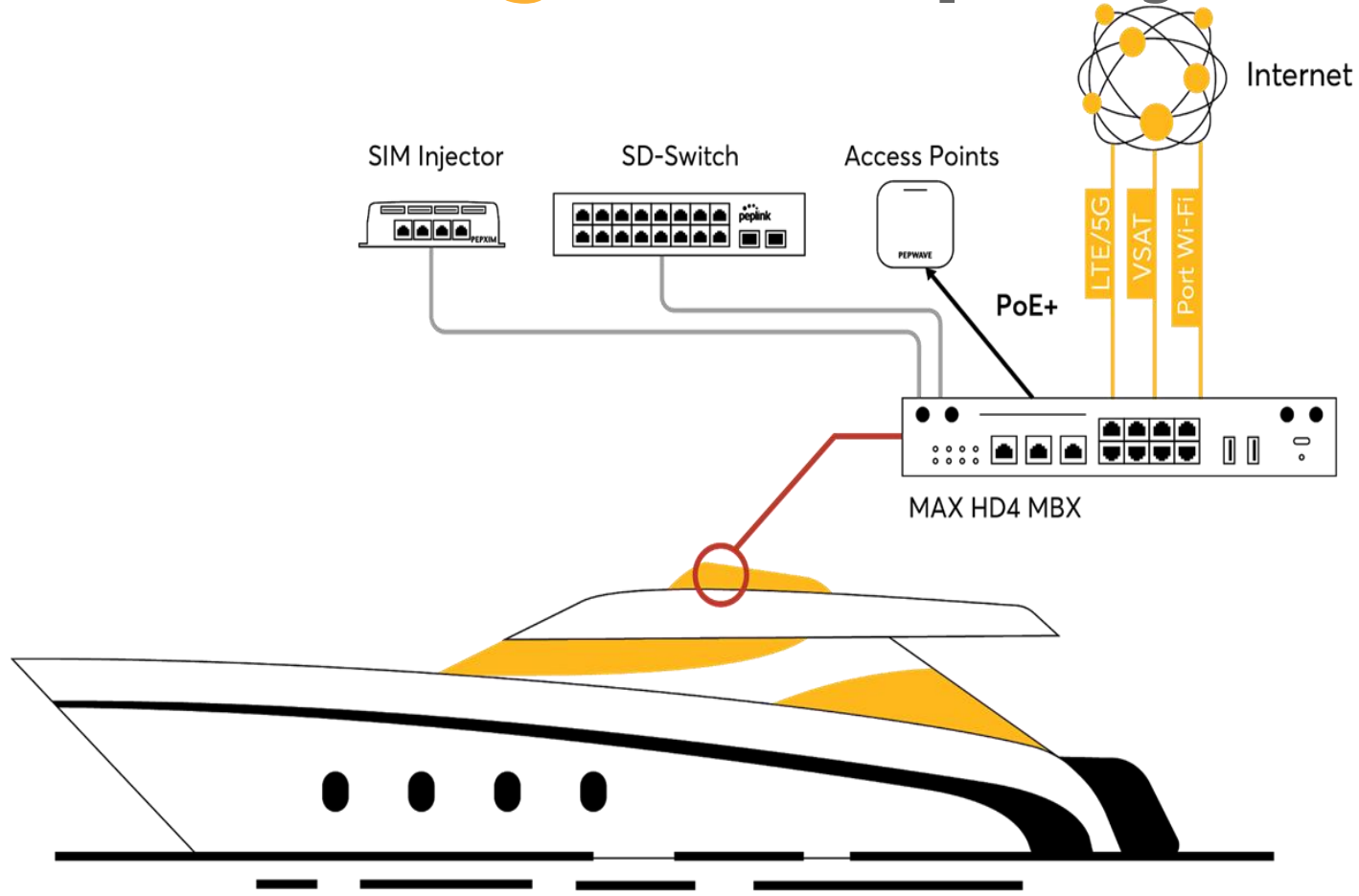

#PeplinkTeknolojiGünü



# Yat Üstünde Bağlantı Topolojisi 2

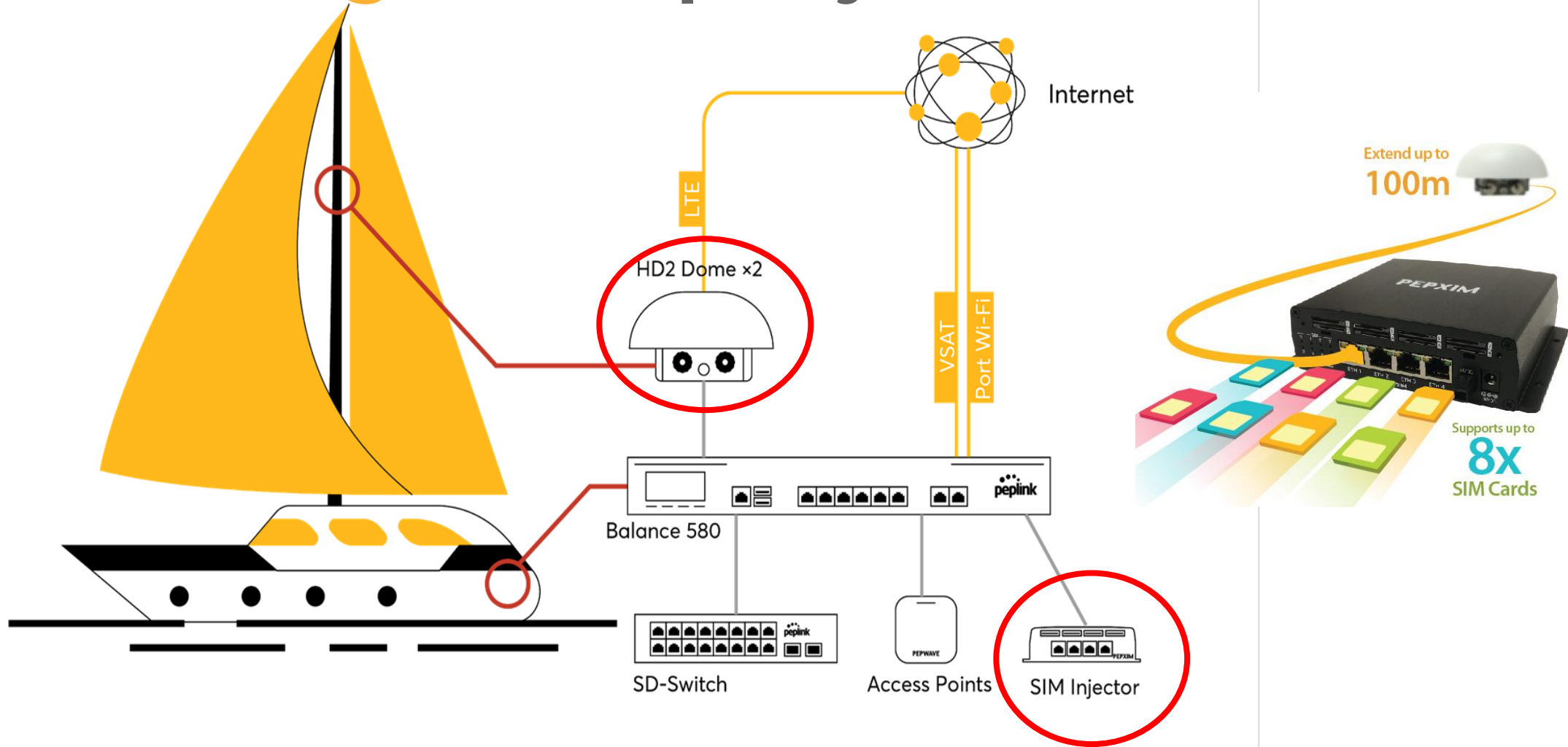

#PeplinkTeknolojiGünü



# Peplink Ekipman

## HD2 Dome | Weatherproof, Powerful Dual Cellular



### HD2 Dome

**Integrated cell antennas** maximizes signal quality

- **Simple Installation** Running a Single Ethernet Cable (No coaxial cables required)
- Dual Cellular - CAT 4, 6, 12 options
- Single Cellular - CAT18 HD1

#PeplinkTeknolojiGünü

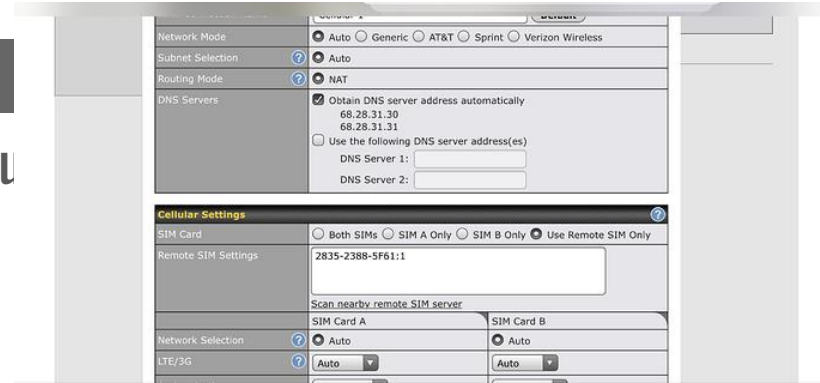

Extend up to  
**100m**

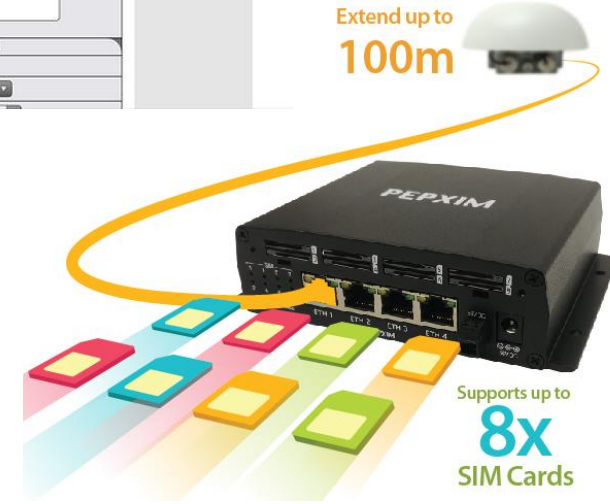

### SIM Injector

Supports up to  
**8x**  
SIM Cards

- Add up to 8x SIMs
- Mount the **HD Dome** on the **Mast** and manage **SIMs** from below decks
- **PoE at Output:** Power HD2 Dome from the SIM Injector



# Peplink Ekipmanlar

MBX | Quad Cellular Gigabit LTE Mobile Powerhouse

Industrial

Transport

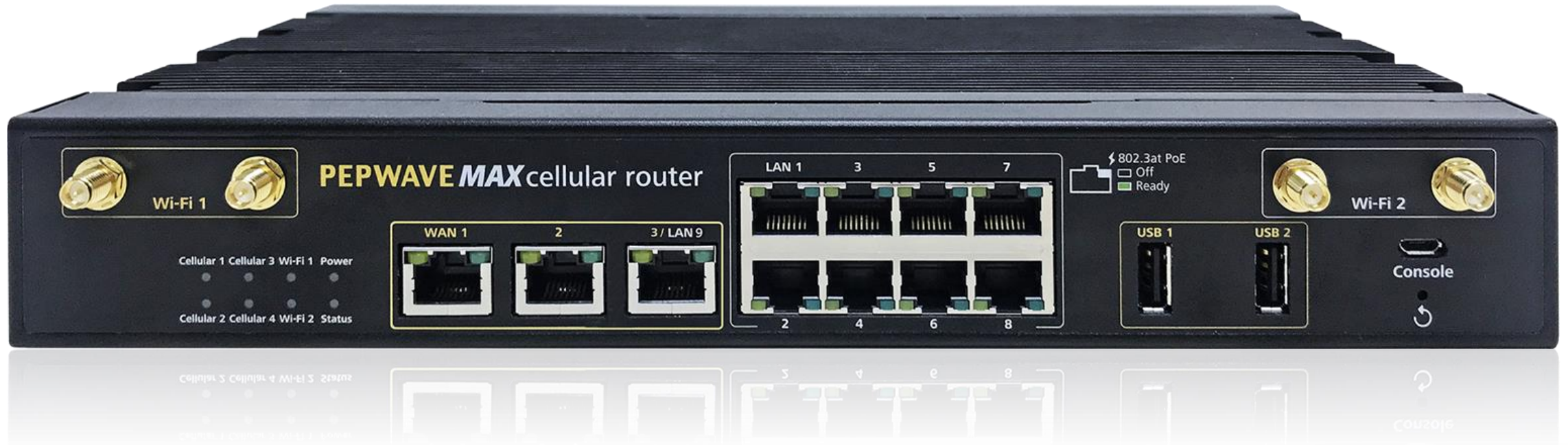

#PeplinkTeknolojiGünü



# Peplink Ekipmanlar

MBX | Quad Cellular Gigabit LTE Mobile Powerhouse

Industrial

Transport

▼ Upgradable Cellular Module, 5G

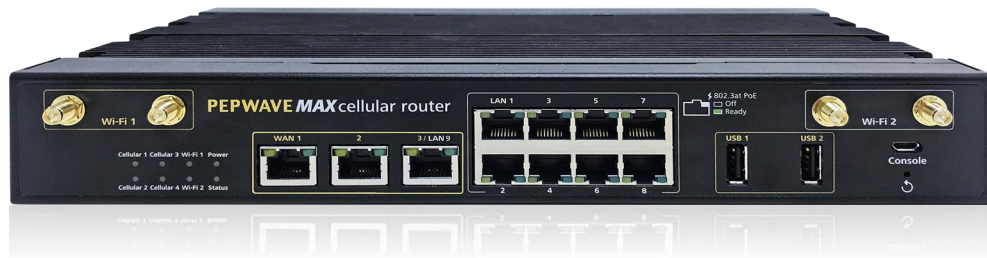

- Supports **Gigabit LTE**
- Features a **swappable cellular module** for **5G upgrade**
- **2.5Gbps of throughput**, giving you plenty of bandwidth for Gigabit Ethernet, 5G, or any future mobile technologies

> [Learn more](#) <

#PeplinkTeknolojiGünü



# Peplink Ekipmanlar

Transit Duo | Multi-LTE Router for Transportation Wi-Fi

Transport

Front

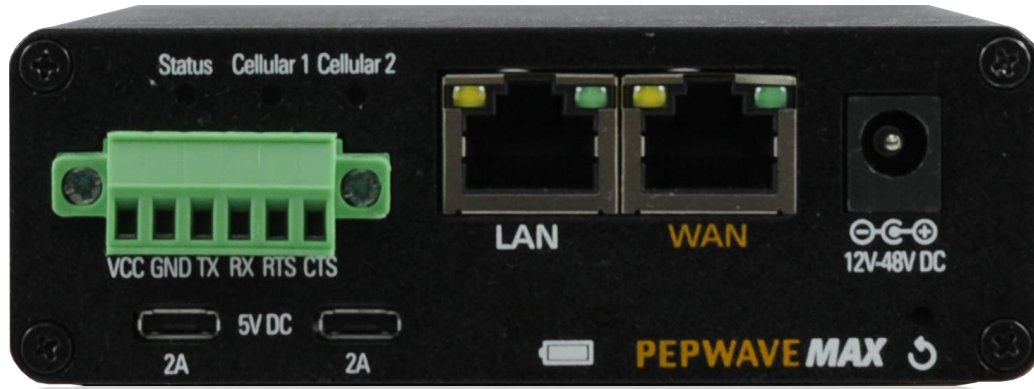

Back



#PeplinkTeknolojiGünü



# Peplink Ekipmanlar: AP One Enterprise AX

Fast, Secure and Manageable Wireless



- **Wi-Fi Standard:** Simultaneous 802.11 **ac/ax**/b/g/n and 802.11 **ac/ax**/a/n
- **Data Rates: 4X4 MIMO**  
2.4GHz: up to 1147 mbps, 5GHz: up to 2402 mbps
- **Transmit Power:**  
2.4GHz: up to 17dBm, 5GHz: up to 17dBm
- **Power Input:**  
12V 2.5A DC Connector OR 802.3at PoE

#PeplinkTeknolojiGünü



# Peplink Ekipmanlar: 16-Port SD Switch

SD Switch Rugged | Industrial-Grade Switch with Cloud Intelligence

Enterprise

Industrial

Front

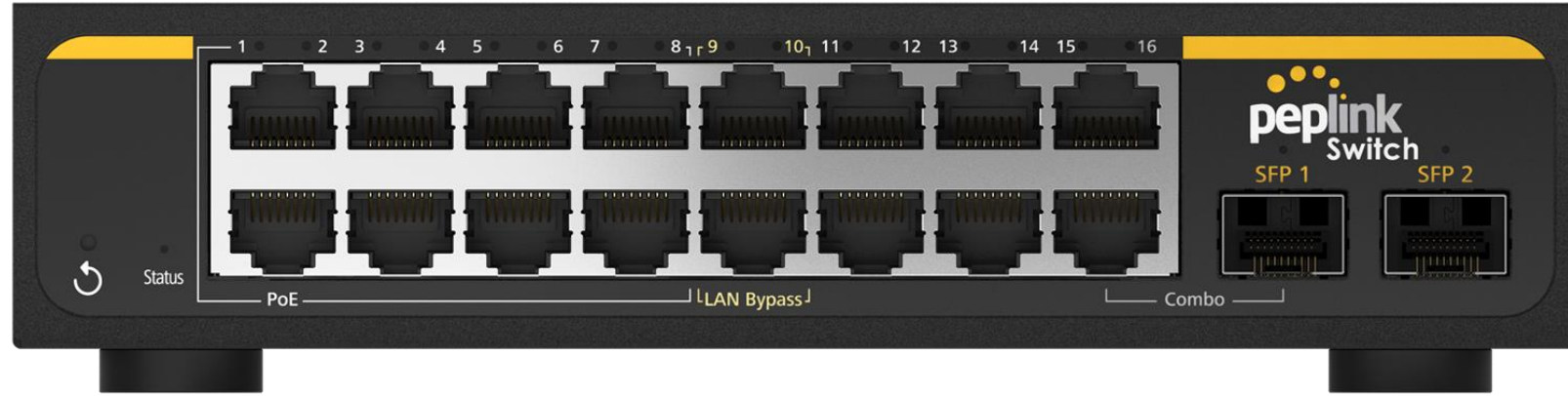

Back



#PeplinkTeknolojiGünü

peplink

vitel



# Peplink Ekipmanlar: 16-Port SD Switch

16-Port SD Switch Rugged Unique features

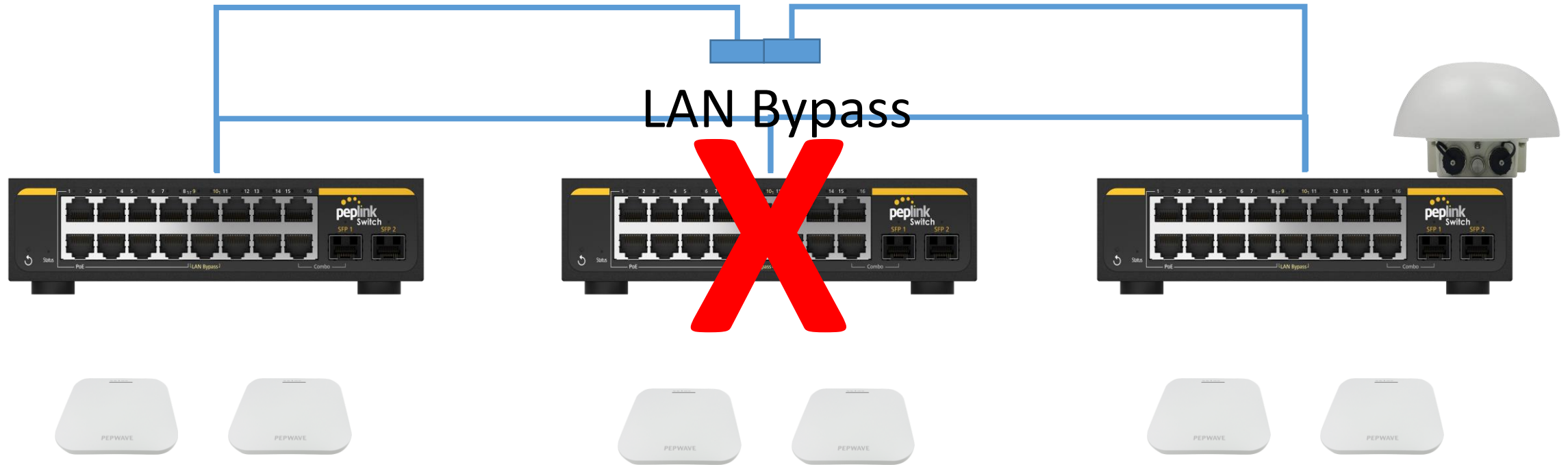

#PeplinkTeknolojiGünü



# Peplink Maritime Yedekli- Kesintisiz

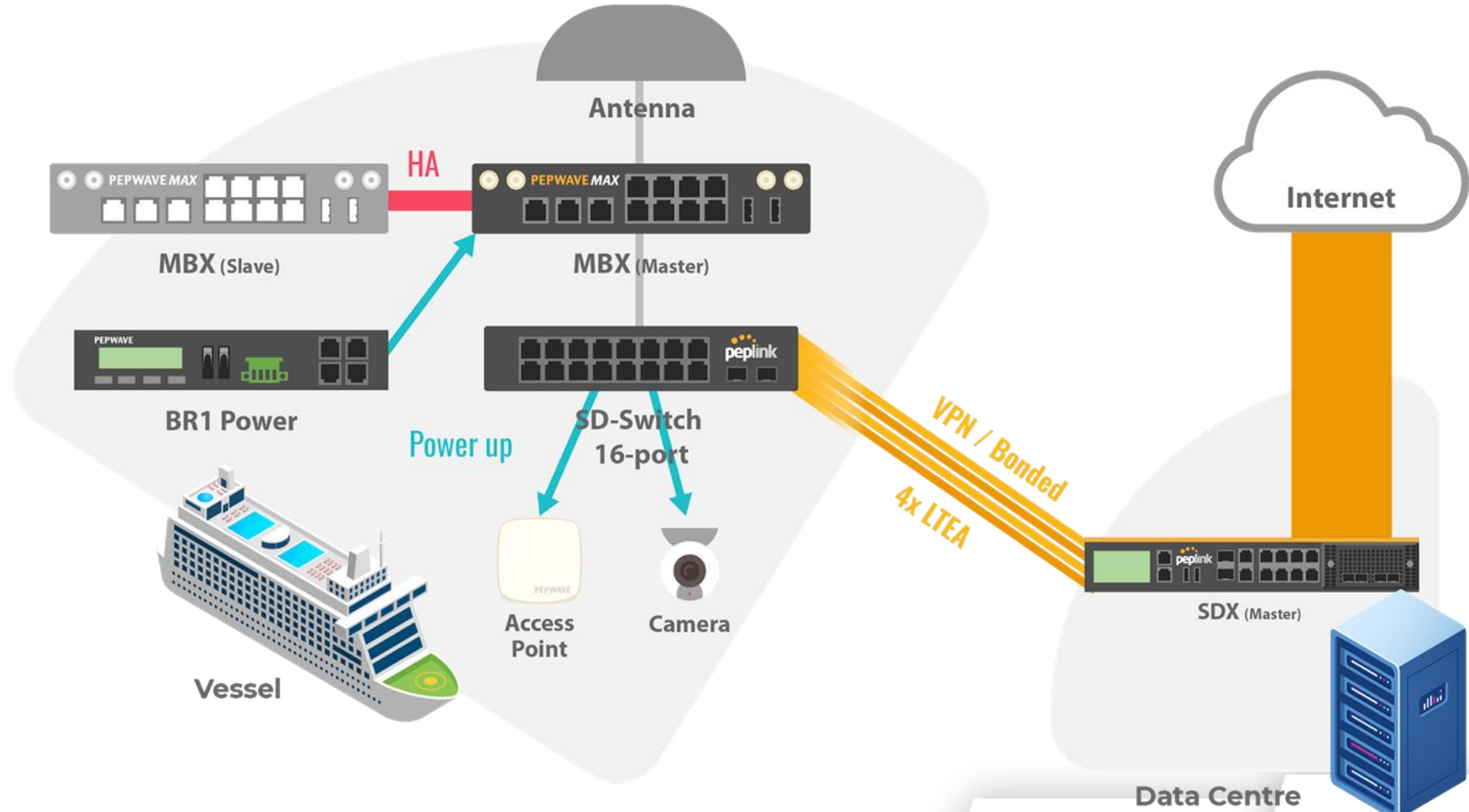

#PeplinkTeknolojiGünü



# Ulaşım ve İnternet (Infotainment)



#PeplinkTeknolojiGünü



# Tren - Onboard

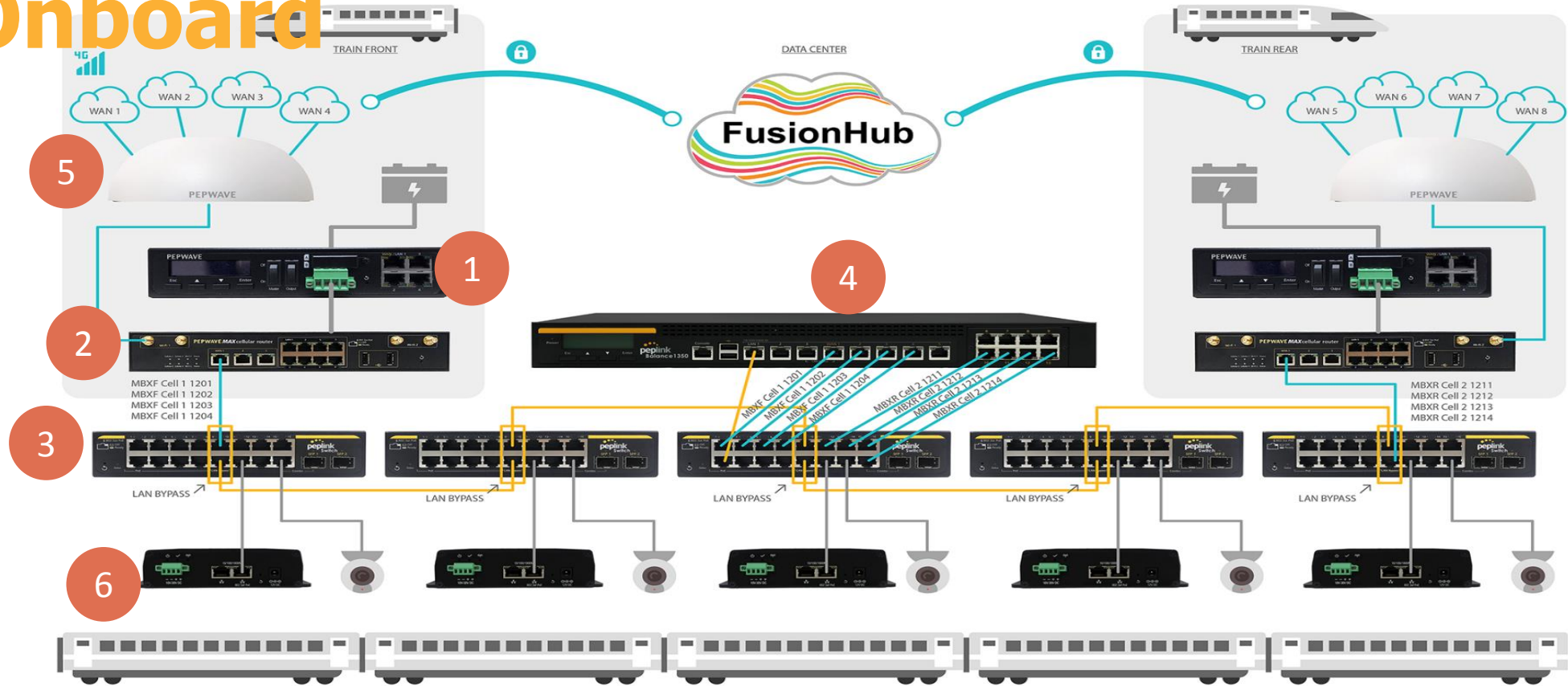

## EN 50155



#PeplinkTeknoloji

5	5				
1		1			
2		2			
3	3	3	3	3	3
4		4			
6	6	6	6	6	6

- 1 MAX BR1 Power
- 2 MAX HD4 MBX
- 3 SD-Switch 16-Port
- 4 Balance 1350
- 5 ANT-100-LTE4-G
- 6 APO Rugged



# 16-Port SD Switch Kurulumu

LAN Bypass Enabled Train Configuration

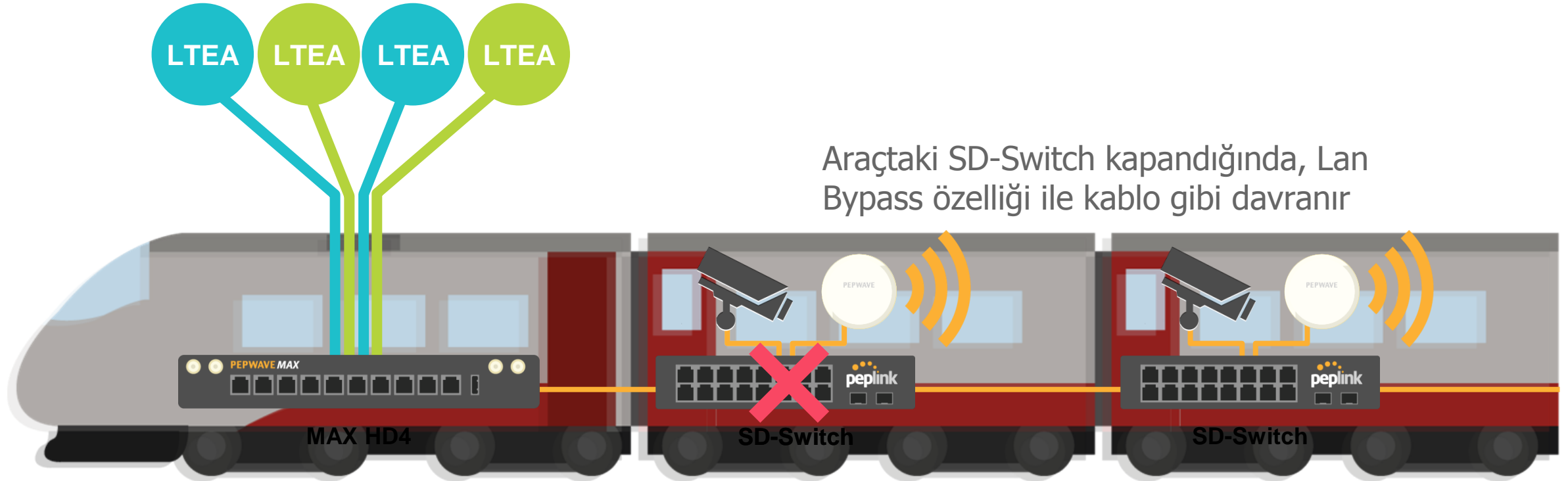

Araçtaki SD-Switch kapandığında, Lan Bypass özelliği ile kablo gibi davranır

Tek limitasyon, 100 metre UTP uzunluğudur

#PeplinkTeknolojiGünü



# Ulaşım: Araç Üstü

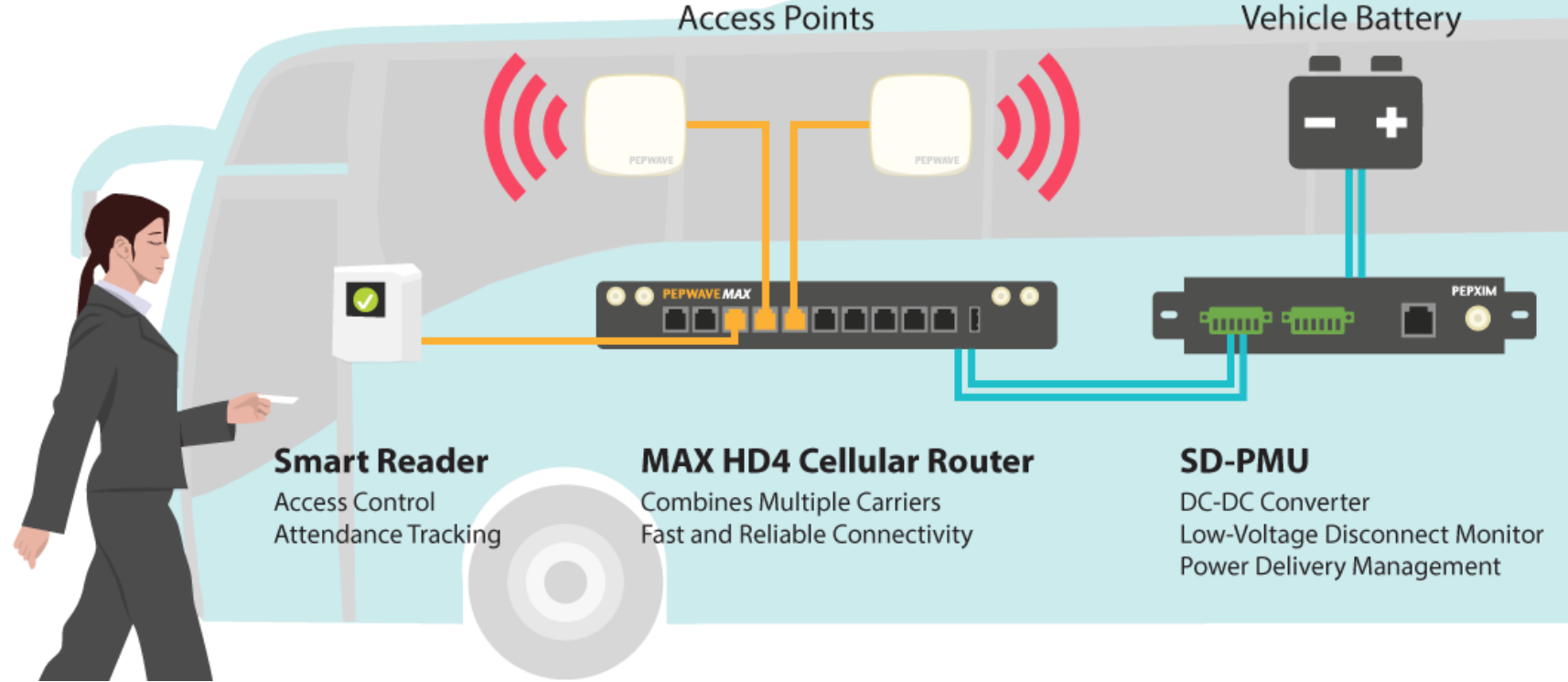

#PeplinkTeknolojiGünü



# Ulaşım: Araç Üstü

Uygulama: Video Streaming

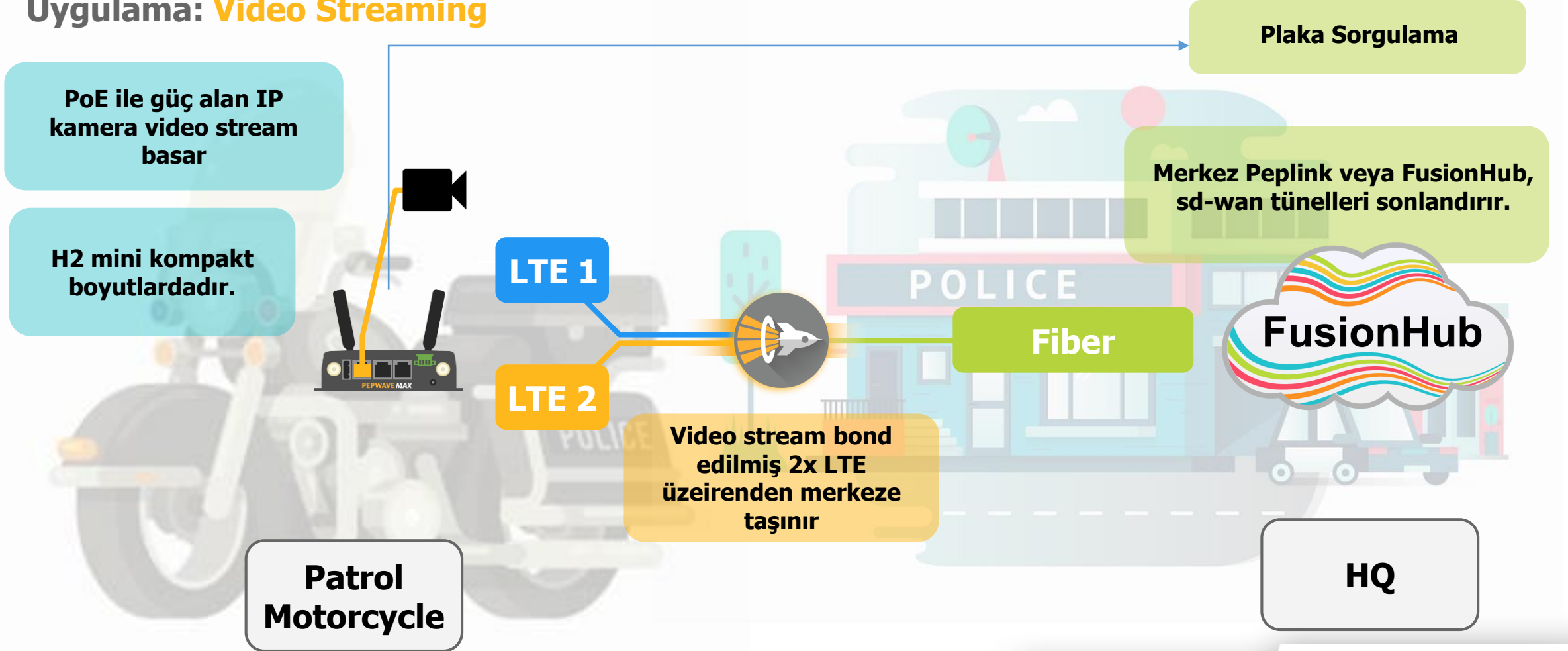

#PeplinkTeknolojiGünü



# Ulaşım: Araç Üstü

Uygulama: Çift yönlü Video konferans



#PeplinkTeknolojiGünü

peplink

vitel



# Layer2 Tunnel ve dot1q trunk

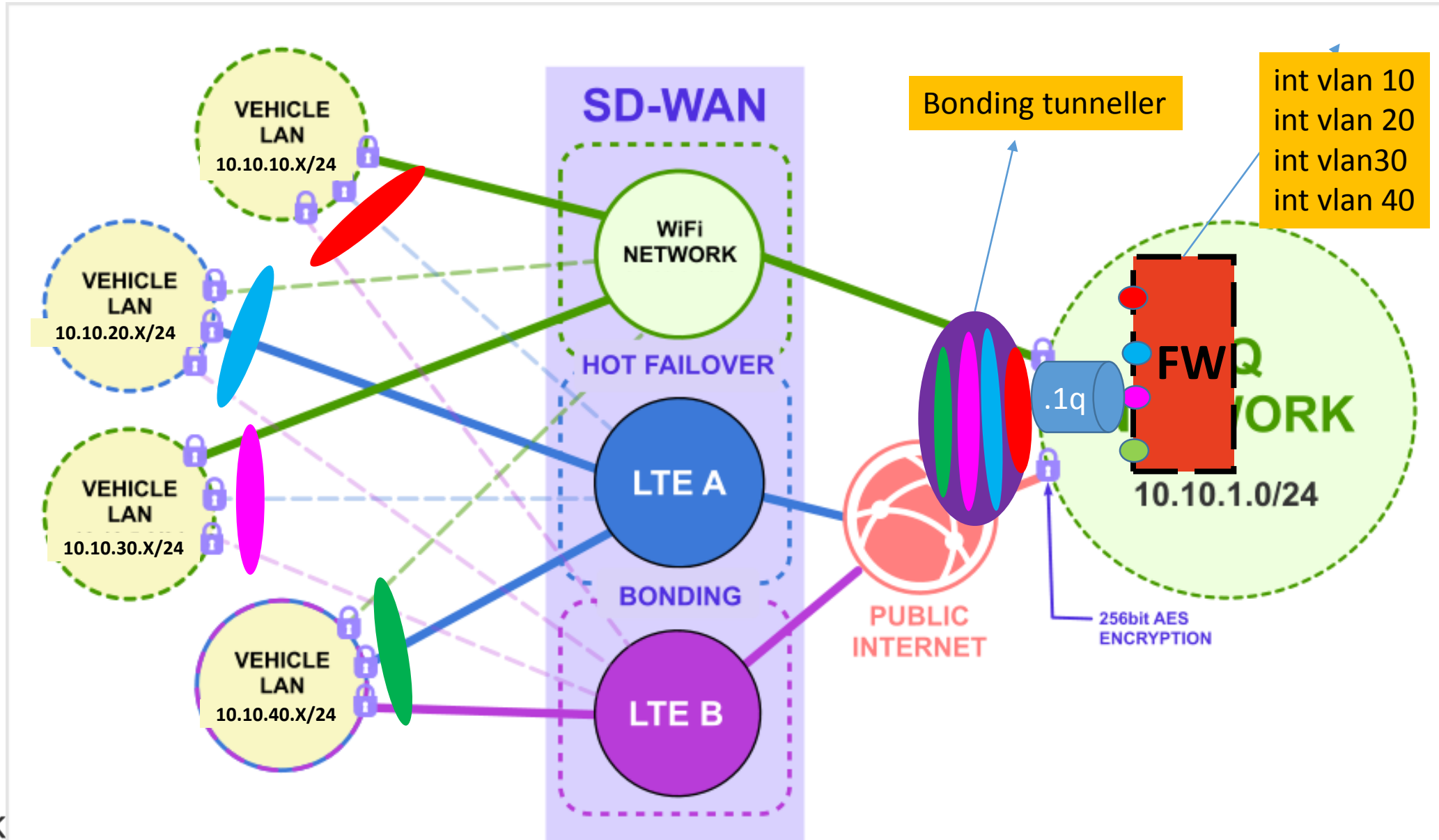

# Layer3 Tunnel NAT Mode, Virtual Network Mapping

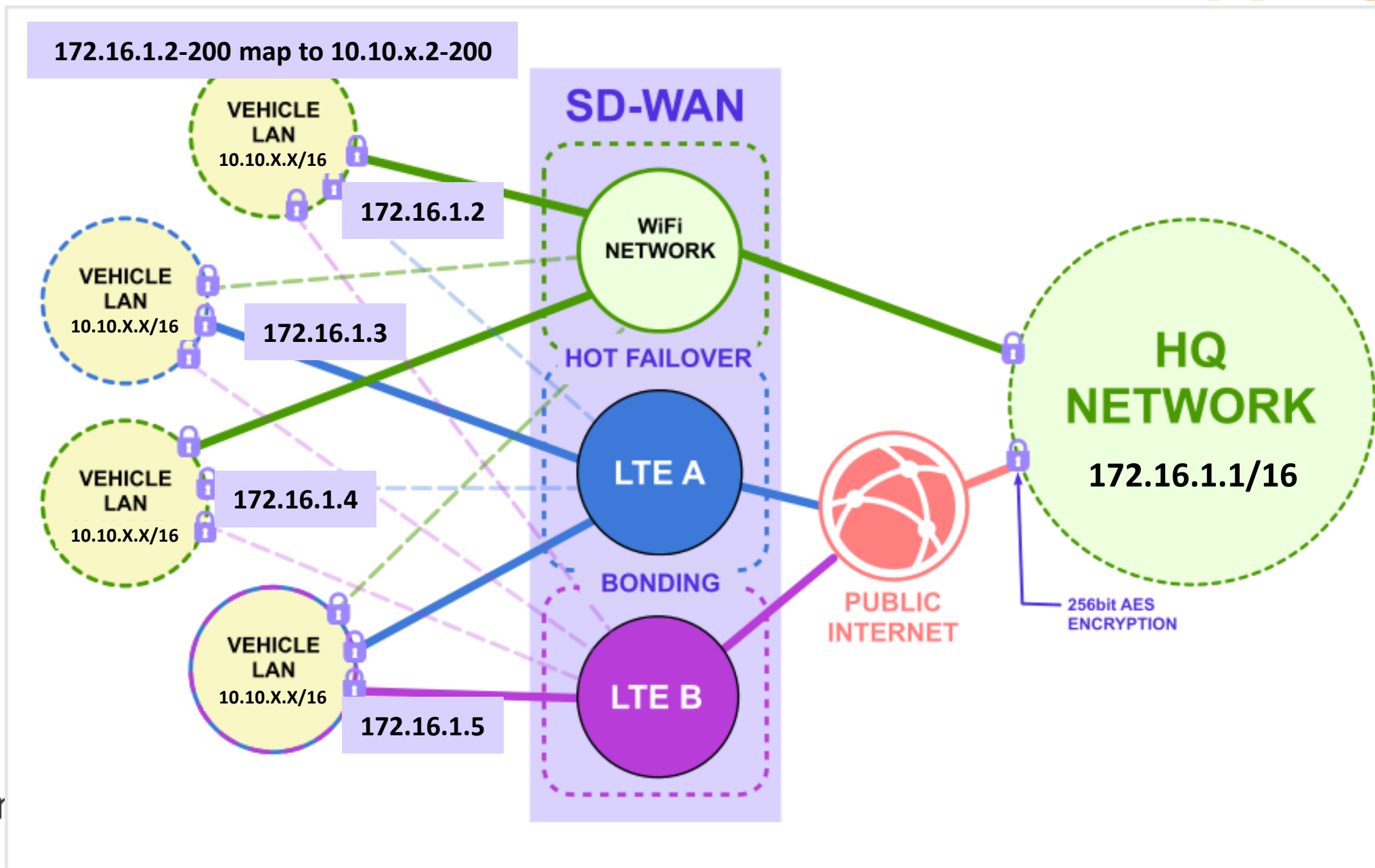

# Robotics & Unmanned Vehicles

SFE : SpeedFusion E

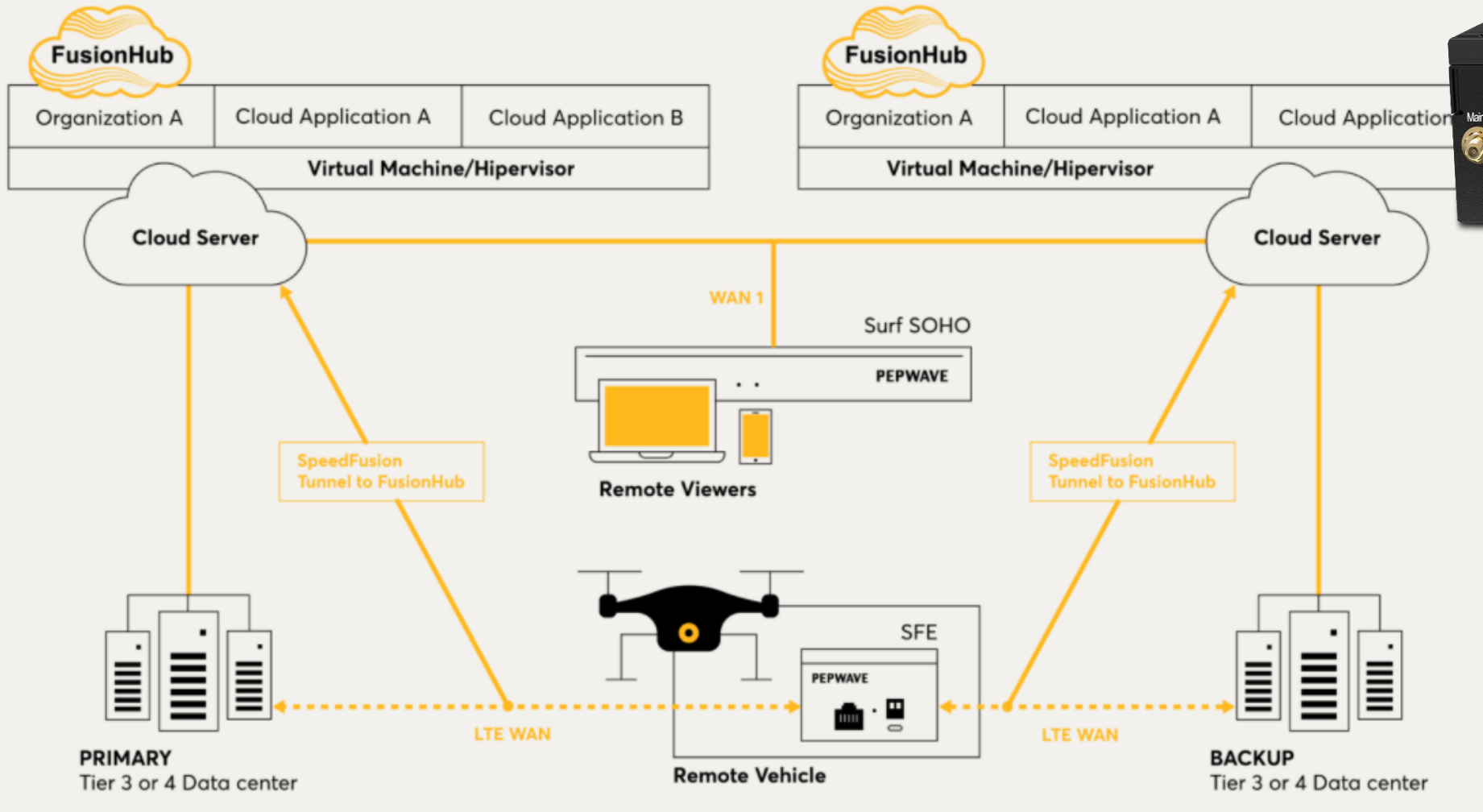

#PeplinkTeknolojiGünü



# Ignition Sensing

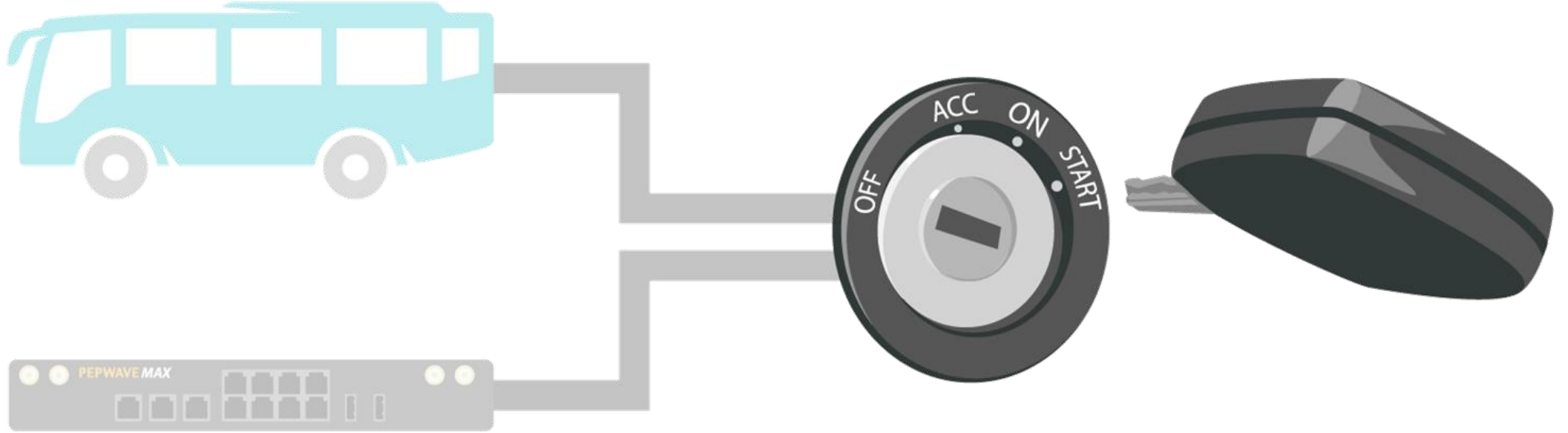

- **Araca marş verildiğinde gücü otomatik olarak verir,** marş kesildiğinde gücü keser.
- **Destekli Modeller:** Transit Mini, HD4, MBX

#PeplinkTeknolojiGünü



# PEPXIM SD-PMU

PowerFusion



SD-PMU, aşağıdaki üç cihazın fonksiyonlarını tek üniteye toplayarak maliyetlerinizi düşürür, operasyonel kompleksiteyi ortadan kaldırır.

- a low-voltage disconnect monitor
- a DC-DC converter
- and a DC distribution panel

- **Compact and Durable metal enclosure**
  - 7.5x9x1.5in
- **Multiple Power inputs and outputs**
  - 2x 12-56V DC Terminal Block inputs
  - 4x 52V DC Terminal Block outputs

#PeplinkTeknolojiGünü



# SIM Injector

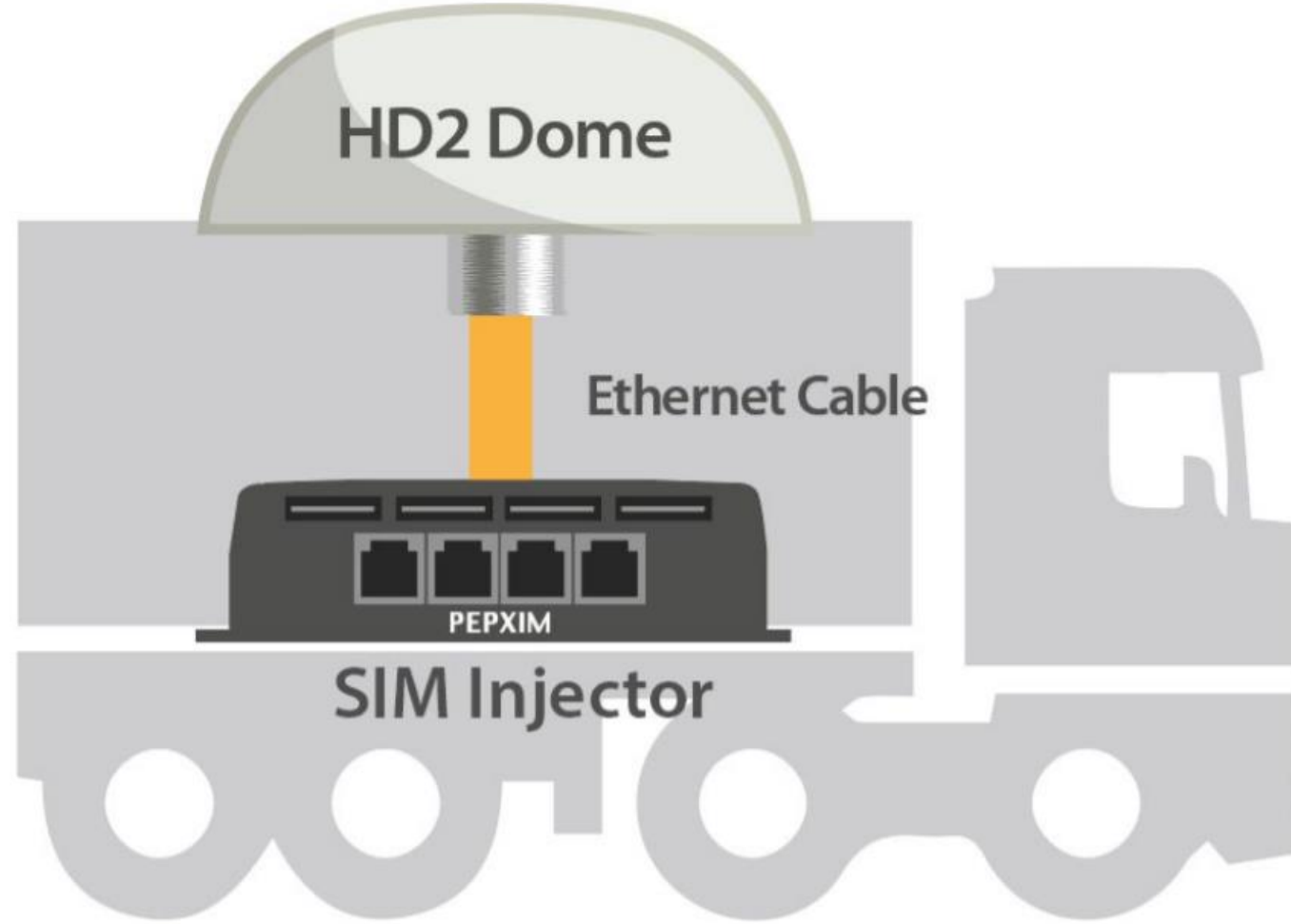

#PeplinkTeknolojiGünü



# MAX HD4 MBX



- 4x LTE-A, LTE-A Pro
- Gigabit LTE
- Cellular modül ile **5G upgrade**
- 2.5Gbps throughput,

#PeplinkTeknolojiGünü



# MAX Transit and Transit Duo



- **2x LTE modem ve 4x yedekli SIMs**
- **Dual Radio 2x2 MIMO Dual-Band Wi-Fi**
- **InControl 2 Cloud NMS ile Fleet Tracking**

#PeplinkTeknolojiGünü





# Uzaktan Kontrol

Tablet Connection  
(Option 1)

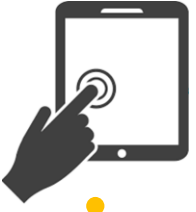

Tablet Connection  
(Option 2)

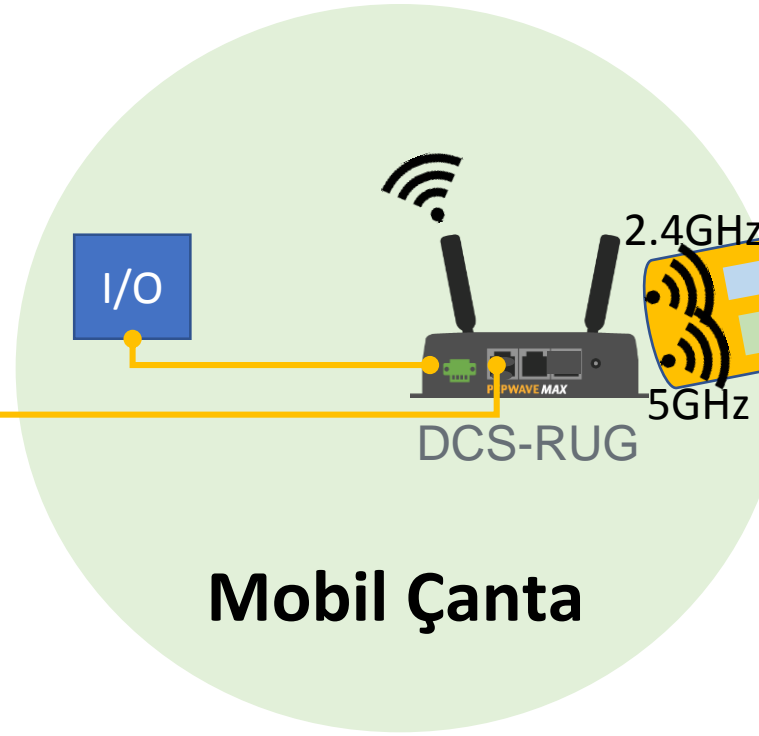

**Mobil Çanta**

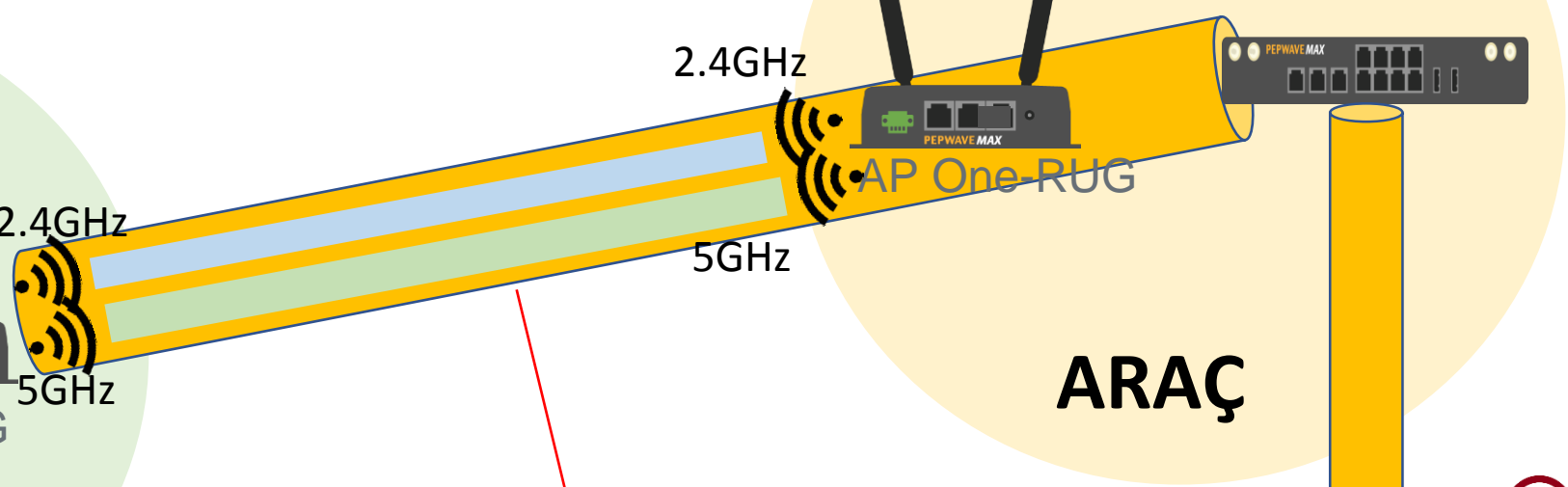

**ARAÇ**

2.4GHz and 5GHz Bonding tunnel  
Zero packet Loss

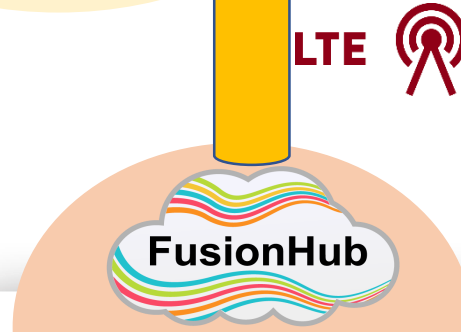

**Kontrol Merkezi**

#PeplinkTeknolojiGünü



# Otoyol Çözümleri VMS/VTS



4G/5G  
4G/5G

2

Wireless router,  
merkezdeki Router'a  
**SpeedFusion** VPN  
tünel ile bağlanır



Internet

4

FTTH

Data  
Center



3

**Wired router,**  
merkezdeki  
DataCenter'da  
kurulu.

#PeplinkTeknolojiGünü



## otomasyon

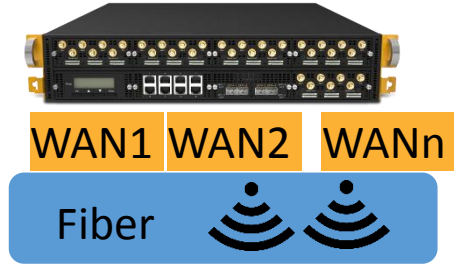

Fiber

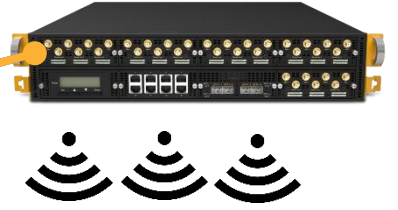

AKM



FKM

Fiber



#PeplinkTeknolojiGünü



peplink

#PeplinkTeknolojiGünü

TEŞEKKÜRLER

SpeedFusion Cloud

vitel.com.tr

vitel

